

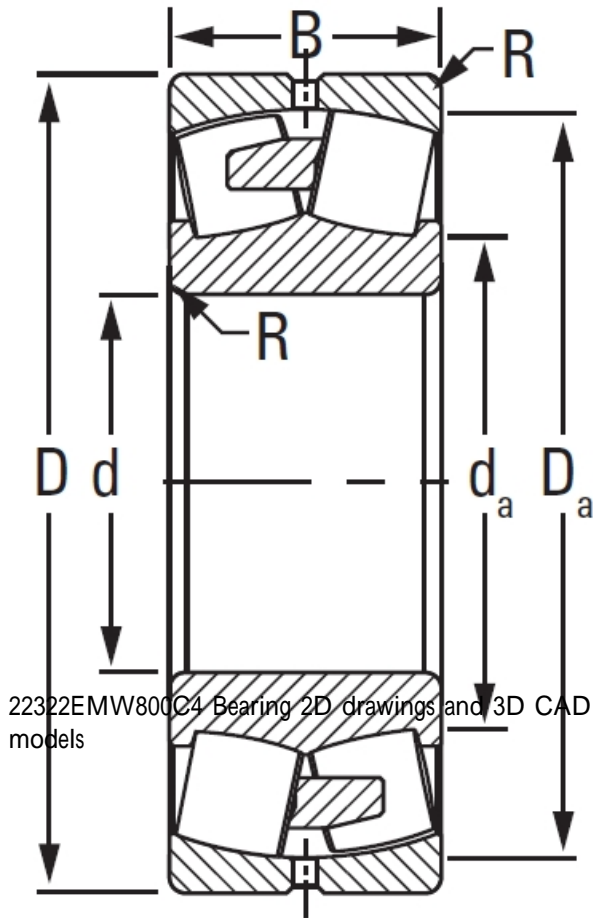

BEARING CORP.

TIMKEN 22322EMW800C4 Bearing

Bearing No. 22322EMW800C4



22322EMW800C4 Bearing 2D drawings and 3D CAD models

Design Unit	METRIC
Bearing Weight	17.8 Kg
Cage Type	EM
UPC Code	087796027176
Cage Material	Brass
Superseded Part	22322YMW800C4
d	110 mm
D	239.993 mm
B - Inner Ring Width	80 mm
B - Outer Ring Width	80 mm
R - Inner Ring To Clear Radius ¹	2.500 mm
r - Outer Ring To Clear Radius ²	2.500 mm
da - Inner Ring Backing Diameter	144.0 mm
Da - Outer Ring Backing Diameter	215.000 mm
C0 - Static Radial Rating	1050000 N
C1(2) - Dynamic Radial Rating (Two-Rows)	949000 N
e - ISO Factor ³	0.32
Y0 - ISO Factor ⁴	2.08
Y1 - ISO Factor ⁵	3.1
Y2 - ISO Factor ⁶	2.04
Reference Thermal Speed Rating (Grease)	2200
Reference Thermal Speed	2500



BEARING CORP.

Rating (Oil) ⁷	
Cg - Geometry Factor ⁸	0.0792